

MODEL : PV-25 [Pneumatic Control Valves]

Connection : Flange PN 16, PN 40, ANSI 150, ANSI 300

V25G globe control valves with linear actuators PA series

DESCRIPTION

The PV25 control valves are single seated, two-way body constructed with in-line straight connections. The PA pneumatic actuator is rubber diaphragm and multi-springs. Its action can be DA -direct action (air to close) or RA-reverse action (air to open). The PV25 valves have been designed to assure an accurate control in any process condition. Their wide application ranges allows the use of this valve with the most common process fluids such as water, superheated water, steam, air, gas and other non corrosive fluids (group 1).

MAIN FEATURES

Single seated, two way, direct or reverse action valve. Valve top flange permanently attached to the body, removal is unnecessary for replacing the actuator. Metal to metal sealing as standard.

OPTIONS:
Position transmitter 4-20 mA
Pneumatic pilot positioner
Electropneumatic pilot positioner
Air filter regulator
Top-work manual handwheel
Stainless steel construction.
Soft sealing and stellite seat and plug.

USE:
Saturated and superheated steam.
Hot and superheated water.
Air, gases and other noncorrosive fluids.

AVAILABLE MODELS: PV25G, PV25S and PV25I
RATINGS: PN16 and PN40
VALVE SIZES: DN15 to DN100

CONNECTIONS: Flanged EN1092-1/-2 PN16 - PN40

ACTUATORS: PA-205; PA-280; PA-340; PA-435
ACTUATOR CONN: 1/4" NPT-F

CONTROL SIGNAL: 0,2 - 1 bar ; 0,4 - 1,2 bar ; 0,4 - 2 bar.

HOW TO SELECT: Never size the valve according to the pipe diameter in which it has to be fitted but according to the required actual flow of steam or water. Refer to valve calculation data sheet or consult the factory.

MAX. AIR SUPPLY PRESSURE: 3,5 bar

AMBIENT TEMPERATURE: -20°C ...+70°C

BONNET : From -5°C to +220°C (standard)
Finned for temperature >220°C

STEM SEALING: PTFE/GR V-Rings - up to 220°C (Standard bonnet)
Graphite - up to 400°C (Finned bonnet)
Stainless steel bellows

PLUG CHARACT.: EQP - Equal percentage
PL - Linear
PT - On-Off

PLUG DESIGN : Contoured
V-ported
Perforated (Low noise, anti-cavitation)
Microflow

PORT : Full port or reduced on request

COMPLEMENTARY INFORMATION : See IS PV10.00 E



CE MARKING (PED - European Directive 97/23/EC)			
PN 16	PN 25	PN 40	Category
DN15 to DN50	DN15 to DN40	DN15 to DN32	SEP - art. 3, paragraph3
DN65 to DN100	DN50 to DN100	DN40 to DN80	1 (CE Marked)
--	--	DN100	2 (CE Marked)

VALVE BODY LIMITING CONDITIONS							
V25G - PN16 *		V25I - PN16 *		V25S - PN40 *		V25I - PN40 *	
ALLOWABLE PRESSURES	RELATED TEMP.	ALLOWABLE PRESSURES	RELATED TEMP.	ALLOWABLE PRESSURES	RELATED TEMP.	ALLOWABLE PRESSURES	RELATED TEMP.
16 bar	-10/50 °C	16 bar	-10/50 °C	40 bar	-10 /50° C	40 bar	-10 /50° C
13,3 bar	200 °C	13,4 bar	200 °C	33,3 bar	200 °C	33,7 bar	200 °C
12,1 bar	250 °C	12,7 bar	250 °C	27,6 bar	300 °C	29,7 bar	300 °C
11 bar	300 °C	11,8 bar	300 °C	25,7 bar	350 °C	28,5 bar	350 °C
10,2	350 °C	11,4 bar	350 °C	23,8 bar	400 °C	27,4 bar	400 °C

Note: Maximum temperature limited to the valve packing selected. Valves with soft seat , maximum allowable temperature : 200°C

* Rating according to EN1092-1:2007

MATERIALS			
POS.	DESIGNATION	MATERIAL V25G - V25S	MATERIAL V25I
1	Valve Body	ASTM A216WCB / 1.0619 ; GP240GH / 1.0619	CF8M / 1.4408
2	Bonnet	CF8 / 1.4308	CF8 / 1.4308
3	Actuator (Steel)	S235JRG2 / 1.0038	S235JRG2 / 1.0038
	Actuator (Stainless steel)	AISI304 / 1.4301	AISI304 / 1.4301
4	*Diaphragm	NBR 70	NBR 70
5	Yoke (Steel)	C45E / 1.1191	C45E / 1.1191
	Yoke (Stainless steel)	AISI304 / 1.4301	AISI304 / 1.4301
6	*Valve plug	PTFE/GR ; St.Steel	PTFE/GR ; St.Steel
7	*Standard packing	PTFE/GR	PTFE/GR
8	*Metal bellows	AISI316Ti / 1.4571	AISI316Ti / 1.4571

* Available spare parts

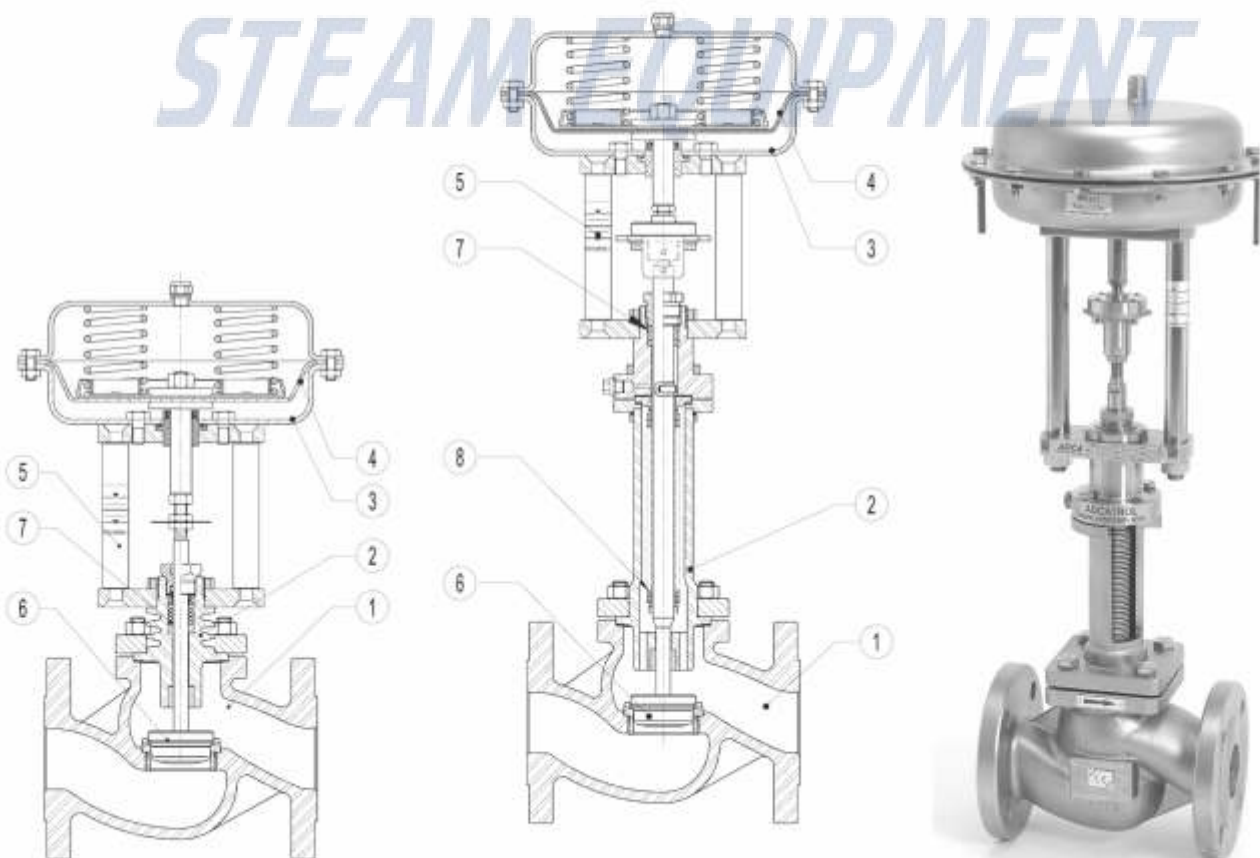

Specification is subject to change without prior notice

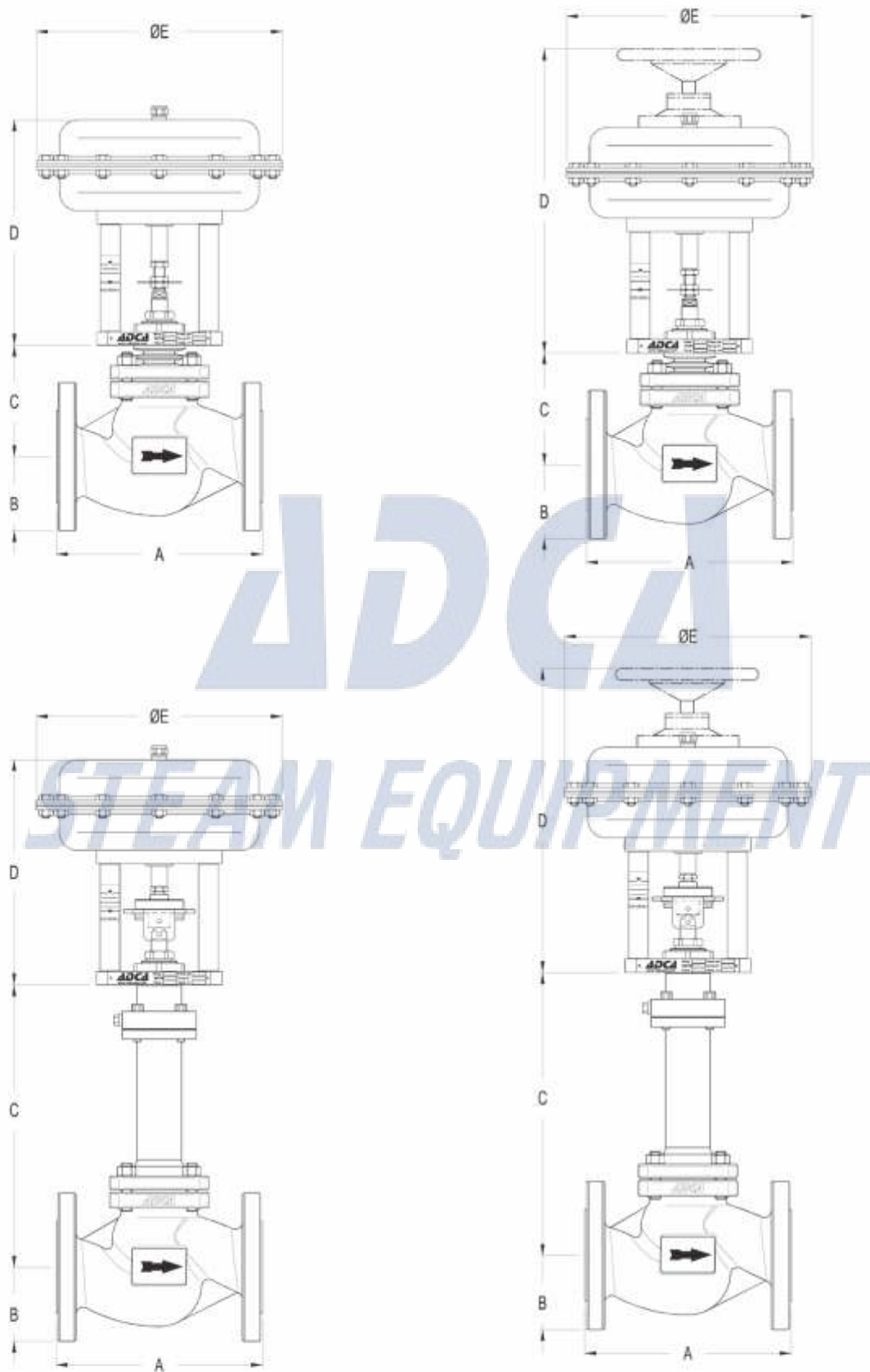

DIMENSIONS - VALVE BODY						
DN	A (mm)	B (mm)	C (mm)			
			BONNET			
			STANDARD	FINNED	EXTENDED	BELLOWS
15	130	48	85	150	150	290
20	150	53	85	150	150	290
25	160	58	90	170	170	295
32	180	70	110	190	190	280
40	200	75	115	195	195	285
50	230	83	125	215	215	285
65	290	93	175	275	275	392
80	310	100	175	275	275	392
100	350	118	190	310	310	400

DIMENSIONS - ACTUATOR			
Type	ø E (mm)	D (mm)	WEIGHT Kgs
		DN15-100 DA/RA	
PA-205	210	235	5,7
PA-280	275	240	8,8
PA-340	335	265	14,3
PA-435	430	295	24,5







PV25 DA - Direct action from DN15 to DN200, PV25 RA - Reverse action from DN15 to DN100

FLOW RATE COEFFICIENTS									
	SIZES								
	DN15	DN20	DN25	DN32	DN40	DN50	DN65	DN80	DN100
Kvs	3,8	5,1	9,4	15,4	22,2	40,1	63,4	89,7	136,7

Kvs in m³/h , see data sheet IS PV10.00 E ; For conversion Kvs = Cv(US) x 0,855

VALVE STROKE IN mm									
	SIZES								
	DN15	DN20	DN25	DN32	DN40	DN50	DN65	DN80	DN100
Stroke	20	20	20	20	20	20	30	30	30

Perforated plug and on-off valves may have different strokes, please see literature or consult factory.

PLUG DESIGN					
Microflow Linear PL	Contoured Equal % or Linear EQP - PL	V - Ported Equal percentage EQP	V - Ported Linear PL	Perforated Equal percentage EQP	Perforated Linear PL
					

V-Ported and perforated plugs are also available in balanced pressure version.

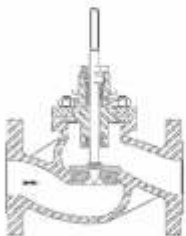
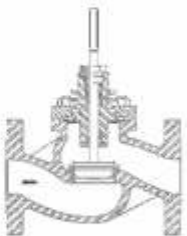
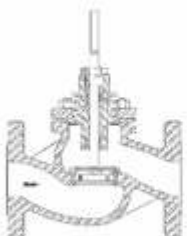
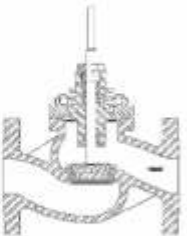
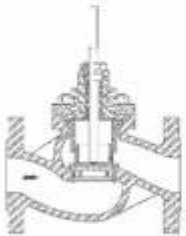
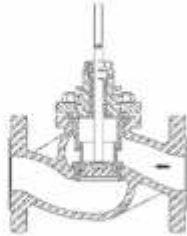
VALVE DESIGN - FLOW DIRECTION					
Microflow Linear PL	Contoured Equal % or Linear EQP - PL	V - Ported EQP - PL	V - Ported Perforated EQP - PL	V-Ported Balanced EQP - PL	Perforated Balanced EQP - PL
					

Specification is subject to change without prior notice

MAX. PERM.PRESS.DROP IN bar - N.C.(fluid to open) -Reverse action actuator (air signal to open)										
ACTUATOR	CONTROL SIGNAL	SIZES								
		DN15	DN20	DN25	DN32	DN40	DN50	DN65	DN80	DN100
PA-205	0,2 ÷ 1 bar	6	6	5	—	—	—	—	—	—
	0,4 ÷ 1,2 bar	10	10	7	—	—	—	—	—	—
	0,4 ÷ 2 bar	12	12	9	—	—	—	—	—	—
PA-280	0,2 ÷ 1 bar	28	26	16	8	6	3,5	—	—	—
	0,4 ÷ 1,2 bar	40	38	20	12	10	5	—	—	—
	0,4 ÷ 2 bar	50	45	25	16	12	6,5	—	—	—
PA-340A	0,2 ÷ 1 bar	60	60	50	20	12	10	—	—	—
	0,4 ÷ 1,2 bar	80	80	60	30	16	13	—	—	—
	0,4 ÷ 2 bar	100	100	80	40	20	18	—	—	—
PA-340B	0,2 ÷ 1 bar	—	—	—	—	—	—	4	2,5	1
	0,4 ÷ 1,2 bar	—	—	—	—	—	—	5	3,5	1,5
	0,4 ÷ 2 bar	—	—	—	—	—	—	6	4	2
PA435A	0,2 ÷ 1 bar	—	—	—	—	40	25	—	—	—
	0,4 ÷ 1,2 bar	—	—	—	—	48	30	—	—	—
	0,4 ÷ 2 bar	—	—	—	—	55	45	—	—	—
PA435B	0,2 ÷ 1 bar	—	—	—	—	—	—	6	5	3
	0,4 ÷ 1,2 bar	—	—	—	—	—	—	8	7	5
	0,4 ÷ 2 bar	—	—	—	—	—	—	10	8	6
	0,4 ÷ 2,5 bar	—	—	—	—	—	—	16	15	12

* For valve size DN125 and above please consult catalogue IS PV25G.125 E.

The pressure drop values are referred to closed valves. They have been verified by a control signal coming from an electro-pneumatic converter with an enduring minimum signal of 0,2 bar.

The actuator press. drops given with closed valve for the actuator signal 0,4 - 2 bar are also valid for ON-OFF service with air supply at 2,5 bar. Special spring drops available on request.

The pressure drop values must be used within the body rating limits.

For electric actuator selection please consult catalogue IS EL.20.00 E or our technical department.

If higher differential pressures are required please consult PA45 pneumatic actuators catalogue.

MAX. PERM.PRESS.DROP IN bar - N.O.(fluid to open) -Direct action actuator (air signal to close)										
ACTUATOR	CONTROL SIGNAL	SIZES								
		DN15	DN20	DN25	DN32	DN40	DN50	DN65	DN80	DN100
PA-205	0,2 ÷ 1 bar	16	16	12	5	—	—	—	—	—
	0,4 ÷ 2 bar	25	24	16	7,5	—	—	—	—	—
PA-280	0,2 ÷ 1 bar	—	—	19	10	8	4	—	—	—
	0,4 ÷ 2 bar	—	—	25	20	16	7	—	—	—
PA-340A	0,2 ÷ 1 bar	—	—	—	17	16	10	—	—	—
	0,4 ÷ 2 bar	—	—	—	28	26	25	—	—	—
PA-340B	0,2 ÷ 1 bar	—	—	—	—	—	—	5	3,5	1,5
	0,4 ÷ 2 bar	—	—	—	—	—	—	8	7	3
PA435B	0,2 ÷ 1 bar	—	—	—	—	—	—	8	5	3
	0,4 ÷ 2 bar	—	—	—	—	—	—	16	10	7,5

* For valve size DN125 and above please consult.

The actuator pressure drops given with closed valve, are obtained with the following air pressures supply:

Actuator signal 0,2 to 1 bar :air supply 1,2 bar ; Actuator signal 0,4 to 2 bar : air supply 2,5 bar

The actuator press. drops given with closed valve for the actuator signal 0,4- 2 bar are also valid for ON-OFF service with air supply at 2,5 bar.

Special spring drops available on request.

The pressure drop values must be used within the body rating limits.

For electric actuator selection please consult catalogue IS EL.20.00 E or our technical department.